



Leading through Innovation

DTS25 / DTS28 Immersion Lamp System

Waterproof UV lamp for UV-C disinfection in rugged industrial design

UV-C immersion lamp systems are frequently used for air, water and surface disinfection (Hybrid-system). They are consisting of a high-performance UV-C lamp, operated inside a rough industrial housing, equipped with energy efficient electronic ballasts and come ready-to-operate.

DTS systems are water-tight and can be operated fully submerged under water (IP68) at up to 2 bar(g) pressure and up to 10 bar (g) when flange mounted. Industrial design without susceptible fine threads. Optionally available with **lampSAFE** shatter protection (up to 2 bar pressure resistant) as well as special versions for up to 20 m cable length. For UPW applications, metal-free version are available.

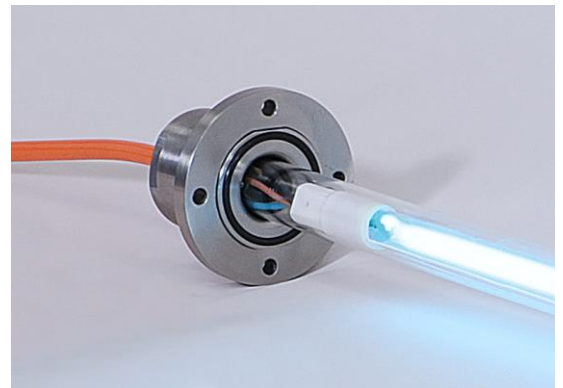

DTS25 - UV-C Immersion Lamp System

Features

- Fully water tight (IP68)
- Robust industrial design without fine threads
- Simple, tool-free lamp replacement
- Form-fit connection of the quartz tube
 - ✓ No accidental pull out possible
 - ✓ Negative pressure operation possible (for fast tank vessel discharge applications)
- Head part internally grounded for lamps with high power
- 12 - 300 W nominal lamp power as standard products
- Modular Plug & Play system with many additional options

Typical applications

- Water disinfection in tanks and reservoirs
- Surface disinfection of evaporators and heat exchangers
- Mounting between transport rollers for surface disinfection
- Water disinfection of humidifiers in HVAC systems
- Knife disinfection in slicers and dicers
- Air disinfection in cooling / standard storage rooms
- Disinfection of the inside of large pack material

TECHNICAL DATASHEET

Technical data – Standard UV-C Systems

General			
Description	DTS 25/354-12	DTS 25/505-21	DTS 25/960-41
Art. No.	30002	30005	30007
Protection class (IP)	IP 68	IP 68	IP 68
Cable length	3 m	3 m	3 m
lampSAFE Shatter protection	option	option	option
Operating in water / in air***	■ / ■	■ / ■	■ / ■
H.S. Code	84212100	84212100	84212100

Lamp data			
Nominal lamp power	12 Watt	21 Watt	41 Watt
Radiation flux @ 254nm	3,4 Watt	7,3 Watt	18 Watt
Typical useful life*	8.000 h	8.000 h	8.000 h

Geometrical Data			
Immersion depth	354 mm	505 mm	960 mm
Sleeve diameter	25 mm	25 mm	25 mm
Diameter head / flange	50 mm / 80 mm	50 mm / 80 mm	50 mm / 80 mm

Power supply			
Description	ALDPG-E020A	ALDPG-E020A	ALDPG-E020A
Art. No.	60358	60359	60359
Material of construction (MOC)	Stainless steel, hygienic design	Stainless steel, hygienic design	Stainless steel, hygienic design
Fault signal contact	■	■	■
Protection class power supply	IP 67	IP 67	IP 67
Mains voltage / Frequency	230 V / 50-60 Hz	230 V / 50-60 Hz	230 V / 50-60 Hz
H.S. Code	85041080	85041080	85041080

Technical data – High power UV-C Systems

General				
Description	DTS 25/505-64	DTS 25/960-110	DTS 28/1207-200	DTS 28/1617-300
Art. No.	30014	30012	30022	30084
Protection class (IP)	IP 68	IP 68	IP 68	IP 68
Cable length	3 m	3 m	3 m	3 m
lampSAFE Shatter protection	optional	optional	Upon request	Upon request
Operating in water / in air***	■ / ■	■ / ■	■ / ■	■ / ■
H.S. Code	84212100	84212100	84212100	84212100

Lamp data				
Nominal lamp power	64 Watt	110 Watt	180 Watt	325 Watt
Radiation flux @ 254nm	20 Watt	43 Watt	50 Watt	105 Watt
Typical useful life**	16.000 h	16.000 h	16.000 h	16.000 h

Geometrical Data				
Immersion depth	354 mm	960 mm	1207 mm	1617 mm
Sleeve diameter	25 mm	25 mm	28 mm	28 mm
Diameter head / flange	50 mm / 80 mm	50 mm / 80 mm	50 mm / 80 mm	50 mm / 80 mm

Optional: EVG in housing				
Description	ALDPG-E040B	ALDPG-E040B	ALDPG-E040B	ALDPG-E090B
Art. No.	60360	60360	60360	60361
Material of construction (MOC)	Stainless steel, hygienic design	Stainless steel, hygienic design	Stainless steel, hygienic design	Stainless steel, hygienic design
Fault signal contact	■	■	■	■
Protection class power supply	IP 67	IP 67	IP 67	IP 67
Mains voltage / Frequency	230 V / 50-60 Hz	230 V / 50-60 Hz	230 V / 50-60 Hz	230 V / 50-60 Hz
H.S. Code	85041080	85041080	85041080	85041080

* / ** / *** see „Special instructions“

lampSAFE shatter protection



Optional: **lampSAFE** Shatter protection for IFS compliant applications

Mettal free version for UPW applications



Optional: Plastic head part for ultrapure water applications or for use in highly corrosive environments

EMV-Version for high power lamps



Optional: Head part with EMC cable gland for cable lengths of 3-20 m and high lamp capacities

Industrial rugged ballast

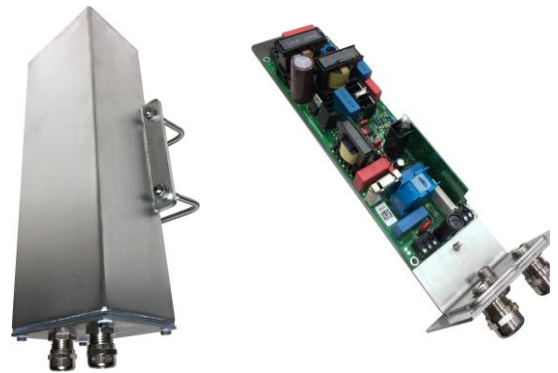

Optional: Industrial ballast in robust stainless steel housing with venting diaphragm (IP 67)

Sketches and drawings are not to scale. Mistakes and subject to change reserved. The latest up to date version of this document is valid. It is the responsibility of the user to check whether he has received the latest version. The reproduction of this document without explicit authorisation in writing by Peschl Ultraviolet is prohibited.

Spectral distribution

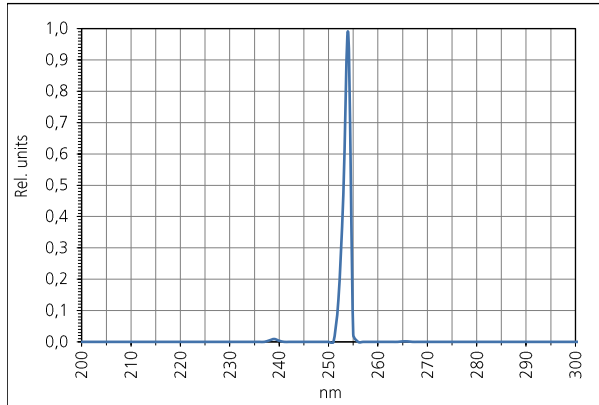

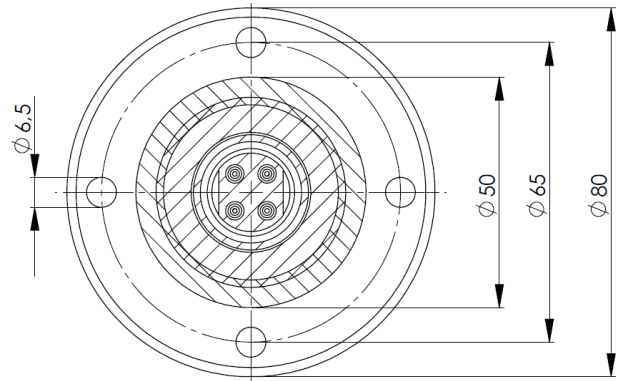

Dimensions of the flange



Through hole in container Ø 30-34 mm
STEP file or DXF file available on request

Safety instructions

WARNING	UV-radiation
	UV-radiation is dangerous for eyes and skin! Never look into direct or indirect radiation without proper personal protection and protect your skin!
WARNING	Breakage of glass
	Risk of cutting. Use cut-resistant gloves when handling glass parts, especially during commissioning and service work.
CAUTION	Mercury
	UV lamps contain small amounts of mercury. In case of lamp breakage, use mercury absorption use mercury binder to collect spills.

Operation on a power supply protected by a ground fault circuit interrupter (GFCI) only!

Special instructions



This product is a component for integration into a over ordinated system by an expert system engineer. It is the responsibility of the user to check the suitability of the component for its individual application and the intended purpose, taking into account the usual care and test under real conditions of use.

The useful lamp lifetime depends on the way of lamp operation and ambient conditions. An unauthorized way of operation as well as the use of components (power supply, cable, plug, etc.), which are supplied by us to us or approved in writing, leads to the exclusion of the warranty!

- * UV-C intensity drop < 35%
- ** UV-C intensity drop < 15%
- *** Adjustment of system according to operating conditions required before delivery

Optional accessories



Stainless steel clamp (#41252)

115V power supplies available upon request